

Varenummer: 025849160060  
Beskrivelse: Norma Connect rørkobling  
COMBI GRIP GL W2 Ø60,3/63 EPDM 16 bar

## Mål

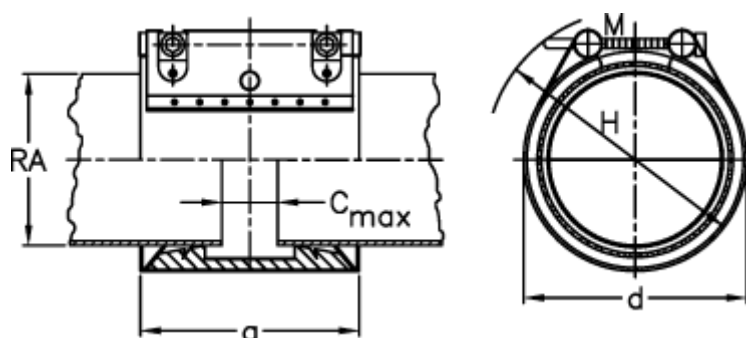

a	= 77.4	RA min-RA max metal = 59,0-61,0
C max med båndindlæg	= 17	Vægt pr stk. = 0.8
d	= 85	
H	= 105	
M (Skrue)	= M8	
Nominelt tryk (bar)	= 16	
RA	= 60,3/63,0	
RA min-RA max kunststof	= 62,5-63,5	